

SOMOS®

MOBILE RESIN DRYER RDM-20/50

ProTec Polymer
Processing

Technical Data

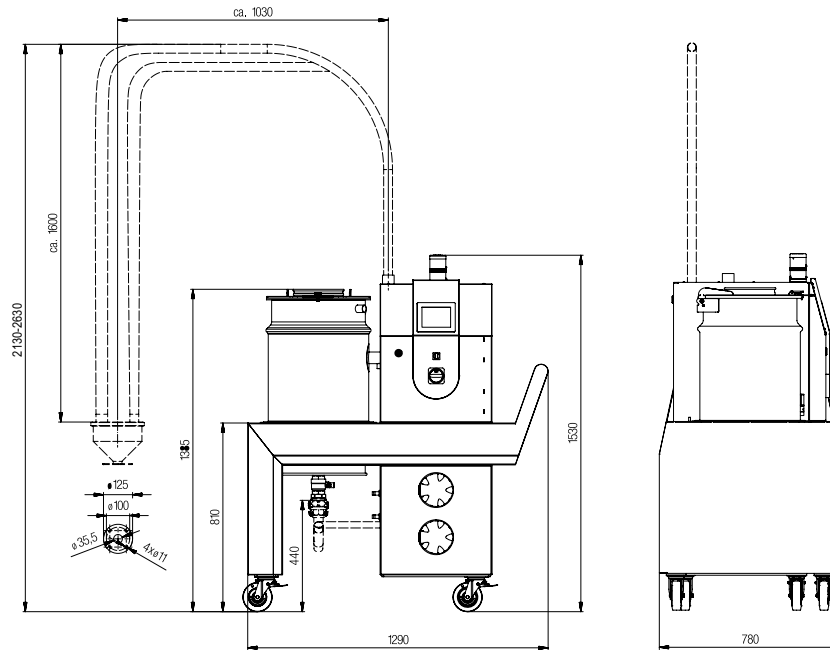

Dry air volume	m ³ /h	20
Dry air temperature		
Standard	°C	60 – 140
High-temperature version (HT)	°C	60 – 180
Low-temperature version (LT)	°C	≤ 60
Dew point	°C	up to -40
Material drying hopper		Stainless steel
HT-version		Stainless steel
Net volume	l	50
Maximum power input		
Blower	kW	0.37
Heater	kW	4.5

Power supply		3N/PE/AC/50Hz/400V/16A
Compressed air consumption (Conveying)		
Pressure	bar	4 – 6
Requirement	m ³ /h	0.1
Cooling water (HT-/LT-version)		
Pressure	bar	2 – 6
Temperature	°C	≤ 15
Requirement	m ³ /h	0.3
Finishing/color	RAL	5018 and 7016
Weight	kg	210 – 235
HT-version	kg	220 – 245

Are you interested in receiving additional information?
Then feel free to call us.

ProTec Polymer Processing GmbH
Stubenwald-Allee 9
64625 Bensheim
Germany

T +49 6251 77061-0
F +49 6251 77061-500
info@sp-protec.com
www.sp-protec.com